

Tolerance, Unless Otherwise Stated, Is				
Above	0.5 to and including	6	±0.1	
Excess	6 to and including	30	±0.2	
Excess	30 to and including	120	±0.3	
Excess	120 to and including	315	±0.5	
Excess	315 to and including	1000	±0.8	
Excess	1000 to and including	2000	±1.2	

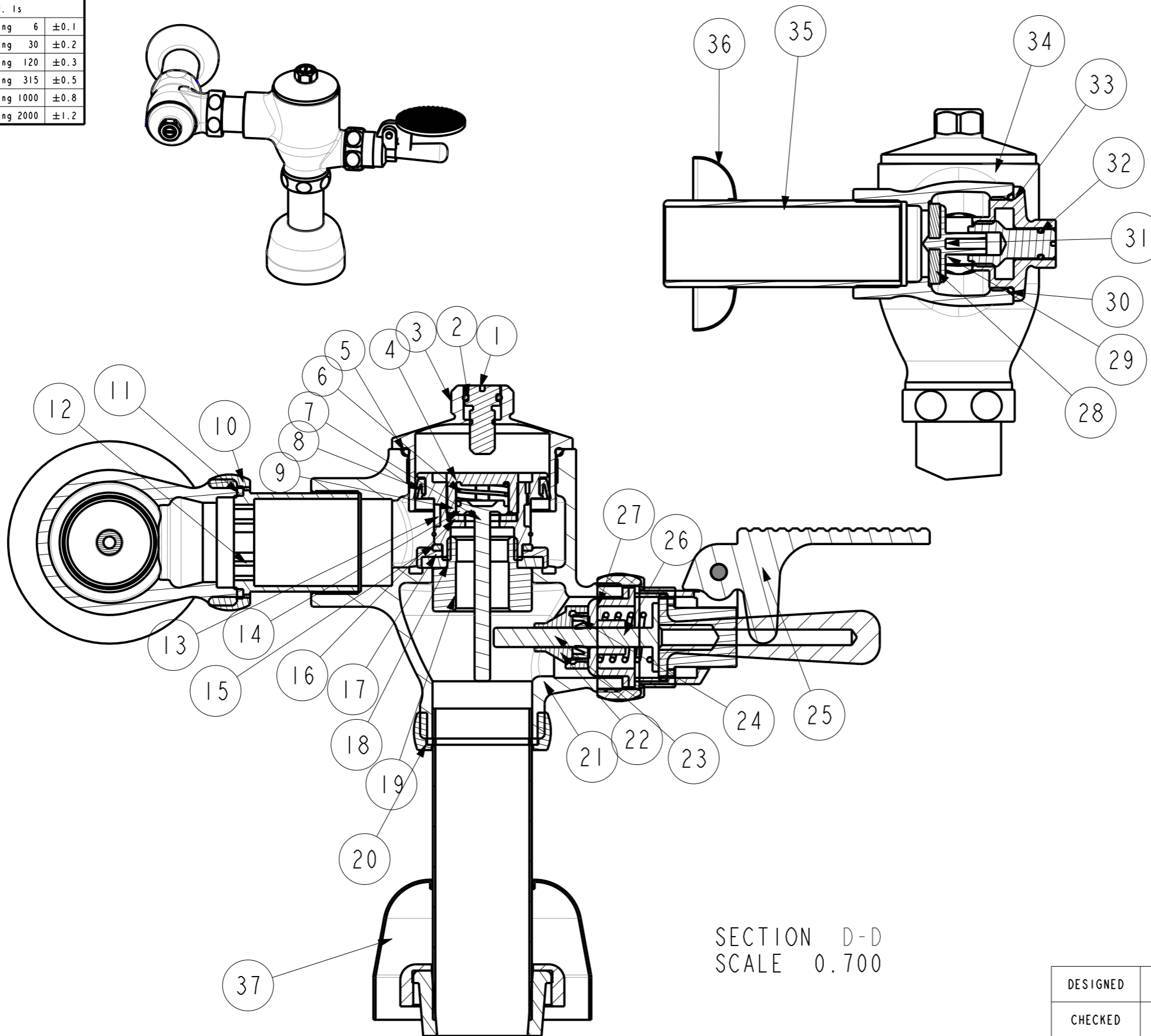

NO.	PART NO.	PART NAME	QTY	MATERIAL	FINISH
37	FF1-CN521F00000100	AS Toilet Flush Valve Escutcheon(Cr)	1	ABS	Chrome
36	FF1-CN521F00000098	AS Toilet Flush Valve Escutcheon(Cr)	1	ABS	Chrome
35	FF1-CN521J00000232	AS Toilet inlet pipe	1	Hpd59-1	Chrome
34	FFZZ9803-00550BDPL	Seat squat toilet body	1	GkM s60Rk	Chrome
33	FF1-CN521G00000116	O-Ring 32.99*2.62	1	NBR70	
32	FF1-CN521G00000115	O-Ring 8*2	1	NBR70	
31	FF1-CN521J00000083	AS Toilet Flush Valve Stem	1	Hpd59-1	
30	FF1-CN521J00000025	AS Toilet Flush Valve Seat	1	Hpd59-1	
29	FF1-CN521J000007099	Stopper	1	POM	
28	FF1-CN521G00000049	Flat Washer ?30* ?4.2*4.3	1	NBR70	
27	FF1-CN521J000007299	Bushing	1	POM	
26	FF1-CN521Z00004899	SPRING	1	IQ18Ni9	
25	FF1-CN521X00007650	Assembling for Pedal of Foot	1	Assembly	Chrome
24	FF1-CN521G00000179	AS Toilet Flush Valve Push Rod Gasket	1	NBR70	
23	FF1-CN521J00000100	AS Toilet Flush Valve PushButton Rod	1	Hpd59-1	
22	FF1-CN521Z00000215	AS Toilet Flush Valve PushRod Cover(W)	1	POM	
21	FFZZ9804-00550BDPL	AS Toilet Flush Valve Body	1	GkM s60Rk	Chrome
20	FF1-CN521N00000016	Nut of flush	1	Hpd59-1	
19	FF1-CN521N00000158	AS Toilet Flush Valve Down-PArc Screw	1	Hpd59-1	
18	FF1-CN521G00000051	Flat Washer	1	NBR70	
17	FF1-CN521F00000016	AS Toilet Flush Valve Seat	1	Hpd59-1	
16	FF1-CN521G00000047	Washer	1	NBR70	
15	FF1-CN521G00000048	Washer	1	NBR70	
14	FF1-CN521Z00000161	A Urinal Flush Valve Spring Ring 29	1	SUS304	
13	FF1-CN521Z00000100	A Urinal Flush Valve FIL TERScreen	1	SUS304	
12	FF1-CN521J00000230	AS Toilet Flush Valve Con Tub	1	Hpd59-1	
11	FF1-CN521G00000028	Flat Washer 36*3*2	1	NBR70	
10	FF1-CN521N00000017	AS Toilet Flush Valve Spout Nut	1	Hpd59-1	
9	FF1-CN521B00000999B	Control Valve Base (0.6mm)	1	Hpd59-1	
8	FF1-CN521G00000182	Gasket for AS Toilet Flush Valve	1	EDPM	
7	FF1-CN521J00000101	Stopper	1	Hpd59-1	
6	FF1-CN521Z00000177	AS Toilet Flush Valve Spring	1	SUS304	
5	FF1-CN521G00000123	O-Ring 44.12*2.62	1	NBR70	
4	FF1-CN521N00000193	AS Toilet Up-Part Fix Screw	1	POM	
3	FF1-CN521F00000022	AS Toilet Flush Valve Up-Cove	1	Hpd59-1	Chrome
2	FF1-CN521G00000115	O-Ring 8*2	1	NBR70	
1	FF1-CN521N00000152	GS Squat Flush Valve Regulate Screw (Cr)	1	Hpd59-1	Chrome

SECTION D-D  
SCALE 0.700

DESIGNED		TITLE	
CHECKED		REF	Foot action Toilet Flush Valve
APPROVED			
SCALE	MATERIAL	WEIGHT	DWG NO. FFAS9806-007500BC0
			<b>American Standard</b>

REV	DESCRIPTION	DATE	NAME