

## Trouble Shooting Guide 一般故障排除指南

Issue 故障	Component 检查点	Checkpoint 内容	Corrective Action 处理办法
Poor flow rate 流量小	Aerator and Shower 起泡器和花洒	Check if is clogged 检查入口处是否有杂质	Remove all impurities 清除杂质
	Water supply valve 供水阀	Check lever position 检查供水阀是否开得太小	Lift lever to maximise water volume 开大供水阀
	Hose 软管	Check if hose is twisted 检查软管是否扭曲	Untwist the hose 展开软管
Leakage 漏水	Cartridge 阀芯	Check cartridge is loosened 检查阀芯是否被松开或损坏	Fasten or replace cartridge 紧固好阀芯或更换新的
	Connection joints 各连接处	Check the connection 检查连接处垫片是否完好	Reassemble connecting part 重新安装
Deviant Temperature 不正常水温	Water supply valve 供水阀	Check lever position 检查供水阀是否开得太小	Lift lever to maximise water volume 开大供水阀
	Water supply system 供水管路	Check if have been correctly connected 检查进水管是否连接正确	Connect the water supply pipe correctly 正确连接冷热水水管



**CN**

- \* 安装须由专业人员进行。
- \* 使用水源: 市政饮用水。(请确保水源清洁, 低质量的水会导致阀芯或内部组件堵塞, 影响产品性能。
- \* 进行清洁时, 请勿使用研磨海绵、擦洗剂、有机溶剂或酸性清洁剂、水垢去除剂、食用醋或含有醋酸的清洁剂。
- \* 本体组已由工厂检验即调试至最佳工作状态, 请勿自行拆装。
- \* 请保管好说明书和特配工具, 以便作维护使用。
- \* 如需维修或有其他故障不能排除时, 请专业人员来解决或打售后服务电话。

**EN**

- \* Product should be installed by a certified plumber.
- \* Ensure clean water source – poor water quality can cause cartridge and internal components to clog, resulting in poor water flow and/or product failure.
- \* Do not use abrasive sponges, scouring agents, organic solvents or acidic cleaners, limescale removers, household vinegar or cleaners containing acetic acid on product.
- \* Product has been fully assembled and inspected in the factory, there is no need to disassemble it/ any components during installation.
- \* Please retain this installation manual and any accompanying tools for maintenance purposes.
- \* Please contact our local after-sales service should the product malfunction/ require repairs.

**TH**

- \* ควรติดตั้งสินค้าโดยผู้เชี่ยวชาญ
- \* ตรวจสอบความสะอาดของน้ำในการใช้งาน เพื่อป้องกันการอุดตันเป็นสาเหตุของารอุดตัน และ ประสิทธิภาพการไหลของน้ำ
- \* ควรใช้ฟองน้ำที่มีความนุ่มทำความสะอาด หลีกเลี่ยงการขัดด้วยอุปกรณ์ที่มีความหยาบ และ น้ำยาทำความสะอาดที่มีฤทธิ์รุนแรง
- \* ห้ามดัดแปลงสินค้า เนื่องจากสินค้าถูกออกแบบมาเพื่อพร้อมติดตั้งและใช้งาน การแยกชิ้นส่วน หรือ ดัดแปลง อาจส่งผลต่อคุณภาพ และ ประสิทธิภาพในการใช้งาน
- \* โปรดศึกษาและปฏิบัติตามคู่มือเพื่อการดูแลรักษาอย่างถูกต้อง
- \* ท่านสามารถติดต่อบริการหลังการขาย เพื่อรับคำแนะนำในการแก้ปัญหาเบื้องต้นด้วยตัวท่านเอง หรือ ขอนัดเพื่อรับบริการซ่อม

**ID**

- \* Produk harus dipasang oleh plumber tersertifikasi.
- \* Pastikan sumber air yang bersih – buruknya kualitas air dapat mengakibatkan cartridge dan komponen didalamnya tersumbat, mengakibatkan aliran air yang kecil dan/atau kegagalan produk.
- \* Jangan gunakan spons kasar, zat pembersih, cairan organik atau pembersih bersifat asam, pembersih kerak, cuka dapur atau pembersih yang mengandung asam asetat pada produk.
- \* Produk telah dirakit dan diperiksa seutuhnya di pabrik, tidak perlu untuk membongkar produk/komponen apapun selama proses pemasangan.
- \* Tolong simpan petunjuk pemasangan ini dan peralatan bawaan untuk keperluan perawatan.
- \* Silahkan hubungi layanan purnajual kami jika ditemukan produk tidak berfungsi/ membutuhkan perbaikan.

**VN**

- \* Sản phẩm nên được lắp đặt bởi một người có kinh nghiệm.
- \* Đảm bảo nguồn nước sạch. Chất lượng nước bẩn có thể làm cho van điều khiển lưu lượng và các linh kiện bên trong bị nghẹt, dẫn đến lưu lượng yếu hoặc gây nên lỗi cho sản phẩm.
- \* Không sử dụng miếng bọt biển mài mòn, chất tẩy, dung môi hữu cơ, hoặc chất tẩy tính axit, chất tẩy rửa cặn ri, giấm hoặc chất tẩy rửa có chứa axit acetic để vệ sinh.
- \* Thân vòi đã được kiểm tra và cam kết bởi nhà máy sản xuất ở điều kiện làm việc tốt nhất. Vui lòng không tháo rời sản phẩm.
- \* Vui lòng lưu giữ hướng dẫn sử dụng và các công cụ chuyên dụng để bảo trì sản phẩm.
- \* Nếu sản phẩm cần được sửa chữa hoặc bị trục trặc gì, bạn có thể gọi thợ tới giải quyết hoặc gọi cho phía dịch vụ sau bán hàng.

**DESIGN + ENGINEERING  
AMERICAN STANDARD**

FF1-CN521K00674599/A1

www.americanstandard-apac.com

*American Standard*

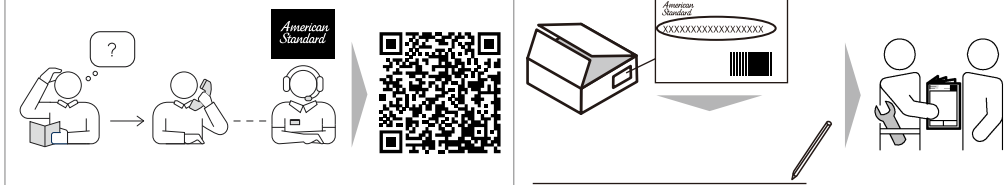
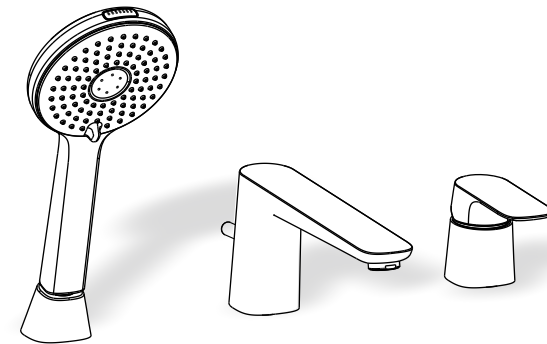
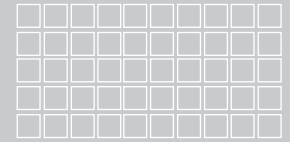

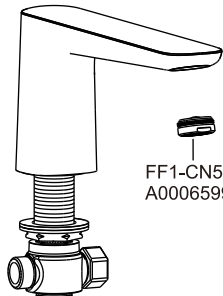
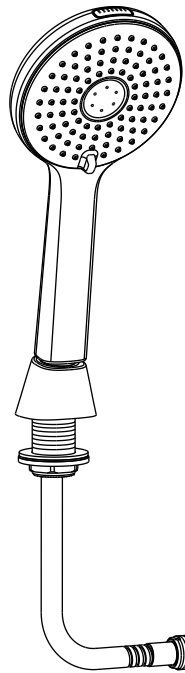

FF1-CN521  
A0006599U

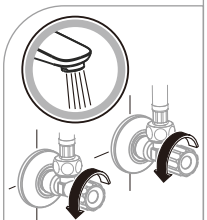
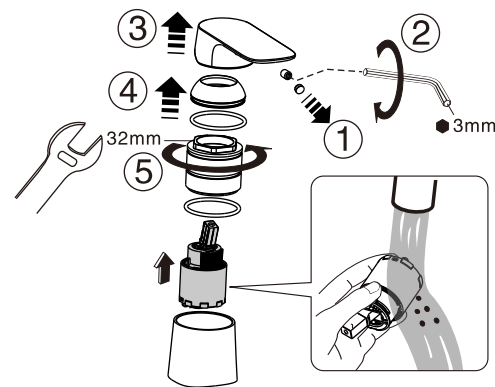
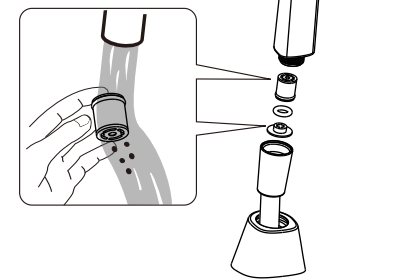
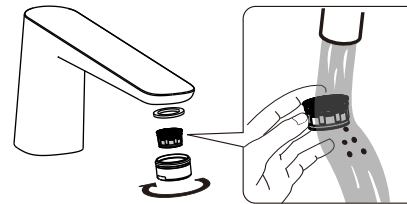
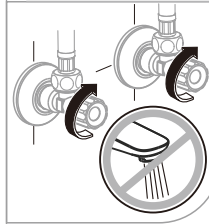
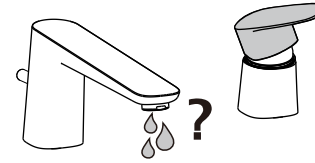
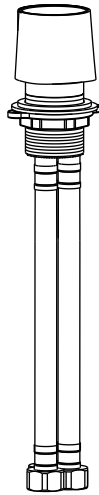
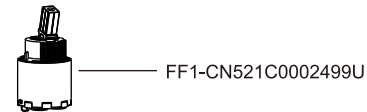
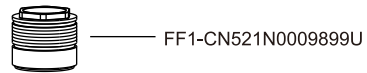
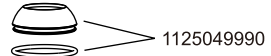
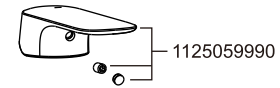



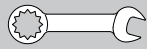

Preparation  
安装前准备

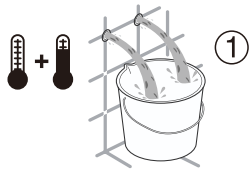

\* Wash and clean the water supply pipeline.  
\* 连接供水管前，请先冲洗干净供水管路。

