

Install (example)

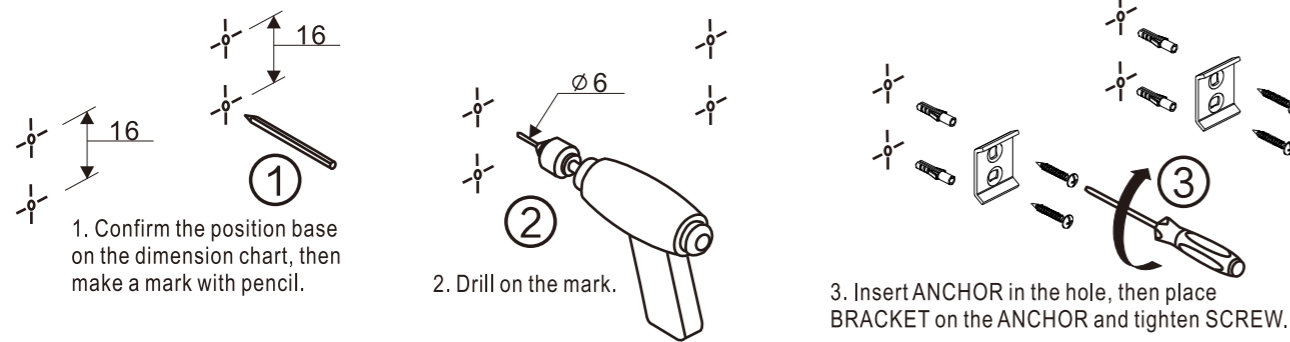

Note: The distance between both BRACKET would be adjustable.

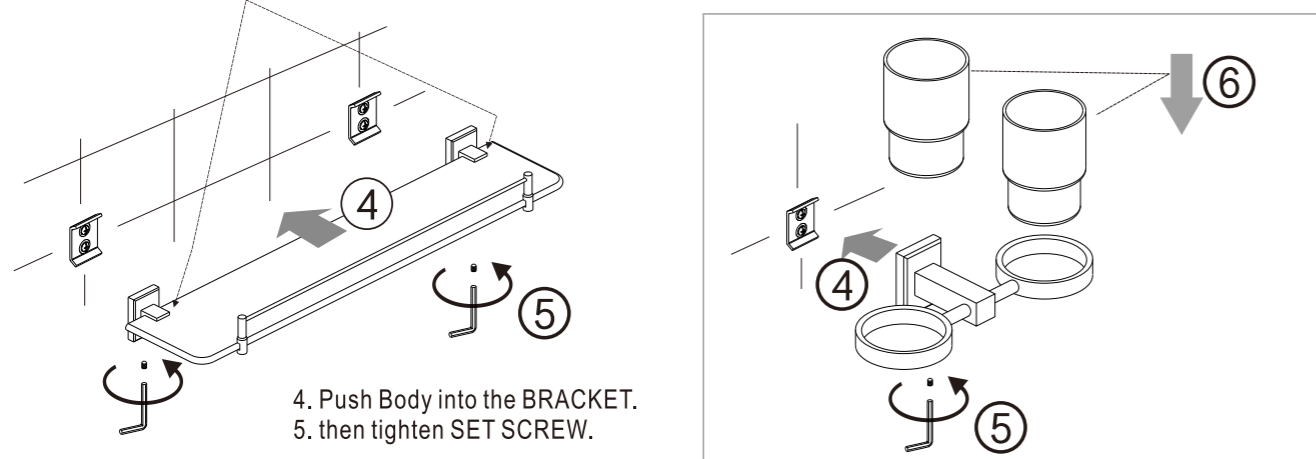

Care & Maintenance

Note: Can not be loaded over 5 kg;

Plasterboard installations should be screwed into a stud, noggin, or be otherwise appropriately reinforced.

- * Rinse the product with clean water.
- * Dry with soft cotton flannel cloth.
- * Do not clean the product with acid, polish, abrasives, harsh cleaners, or cloth with a harsh surface as these products may damage the finish.

Warranty

This Product is covered by a 3 year warranty

We do not grant warranty for faults caused by

- * Unsuitable or improper use
- * In correct installation
- Installation or part installation by the purchaser or any person other than a LICENSED PLUMBER
- * Normal wear and tear
- * Improper or negligent treatment
- * Inadequate or complete lack of maintenance
- * Unsuitable usage
- * Chemical, electrochemical or electrical influences



Attention:
Please leave the manual with the customer after installation is finished.



American Standard

Installation & Operation Instructions

Concept Square Accessories

Thank you for selecting American-Standard - the benchmark of fine quality for over 100 years. To ensure that your installation proceeds smoothly--please read these instructions carefully before you begin.

- * American Standard always keep raising and improving the product design and performance, and reserve the right to modify the dimension and specification. At this case, we will not inform you separately.
 - * This installation instruction sheet is for your reference only, the dimension and specification is subject to the actual products.
- All instruction procedures must comply in strict accordance with applicable local plumbing and building codes

Recommended Tools and Materials



Parts List / Dimension

FFAS0488-908XXXBF0

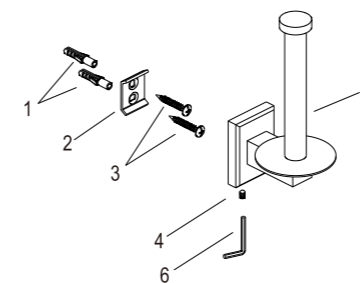

PARTS LIST		
No.	Part Name	Q'ty
1	Anchor	2
2	Holder seat	1
3	Self-tapping Screw	2
4	Set screw	1
5	Body	1
6	Allen Key	1

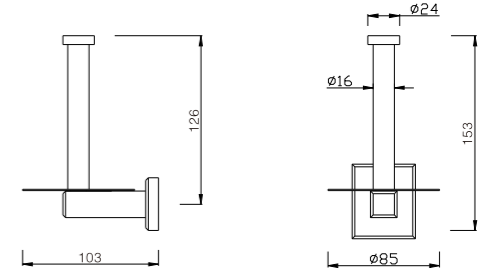

FFAS0493-908XXXBF0

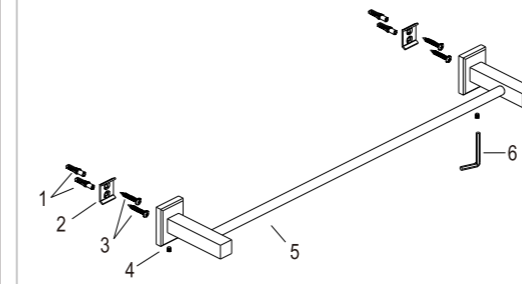

PARTS LIST		
No.	Part Name	Q'ty
1	Anchor	4
2	Holder seat	2
3	Self-tapping Screw	4
4	Set screw	2
5	Body	1
6	Allen Key	1

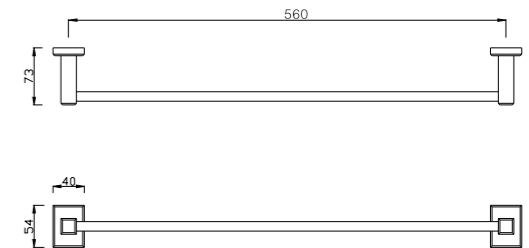

FFAS0494-908XXXBF0

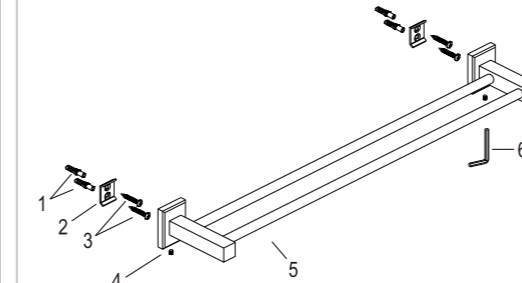

PARTS LIST		
No.	Part Name	Q'ty
1	Anchor	4
2	Holder seat	2
3	Self-tapping Screw	4
4	Set screw	2
5	Body	1
6	Allen Key	1

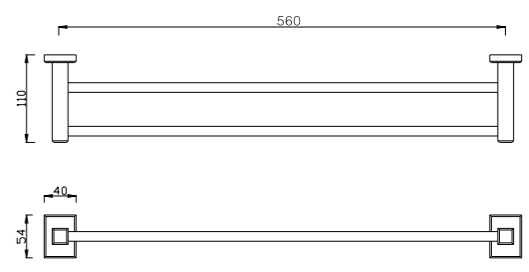

FFAS0481-908XXXBF0

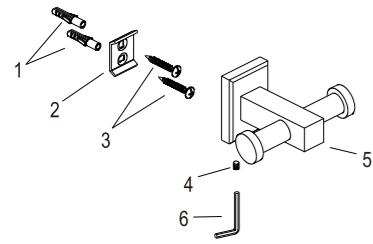

PARTS LIST		
No.	Part Name	Q'ty
1	Anchor	2
2	Holder seat	1
3	Self-tapping Screw	2
4	Set screw	1
5	Body	1
6	Allen Key	1

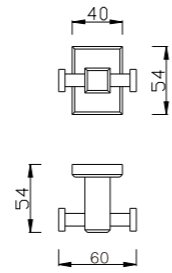

FFAS0484-908XXXBF0

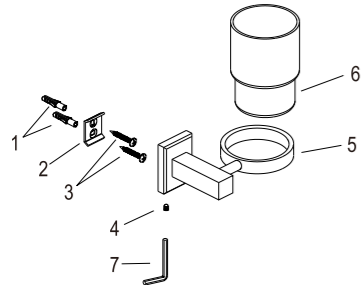

PARTS LIST		
No.	Part Name	Q'ty
1	Anchor	2
2	Holder seat	1
3	Self-tapping Screw	2
4	Set screw	1
5	Body	1
6	Cup	1
7	Allen Key	1

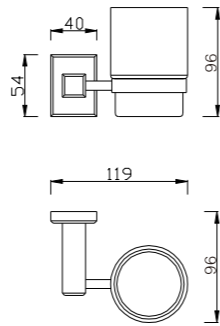

FFAS0482-908XXXBF0

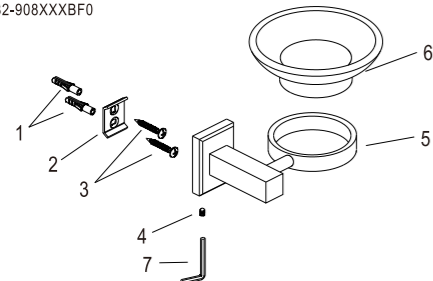

PARTS LIST		
No.	Part Name	Q'ty
1	Anchor	2
2	Holder seat	1
3	Self-tapping Screw	2
4	Set screw	1
5	Body	1
6	Dish	1
7	Allen Key	1

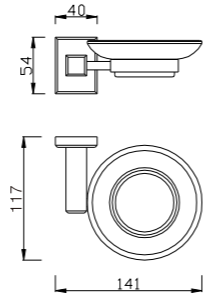

FFAS0490-908XXXBF0

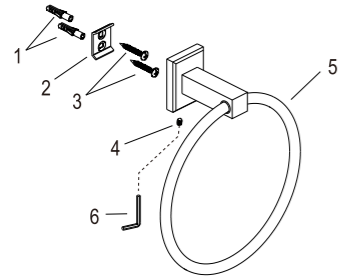

PARTS LIST		
No.	Part Name	Q'ty
1	Anchor	2
2	Holder seat	1
3	Self-tapping Screw	2
4	Set screw	1
5	Body	1
6	Allen Key	1

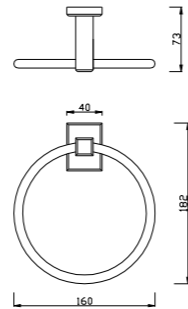

FFAS0489-908XXXBF0

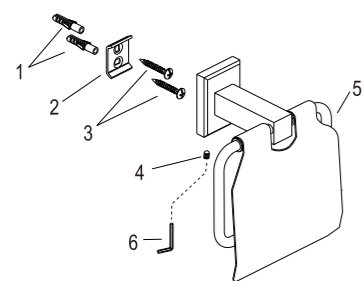

PARTS LIST		
No.	Part Name	Q'ty
1	Anchor	2
2	Holder seat	1
3	Self-tapping Screw	2
4	Set screw	1
5	Body	1
6	Allen Key	1

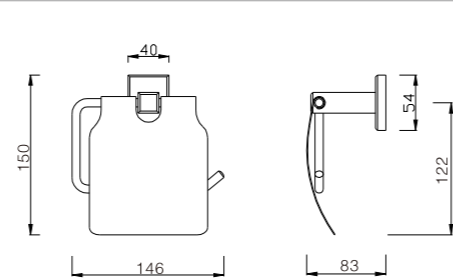

FFAS0485-908XXXBF0

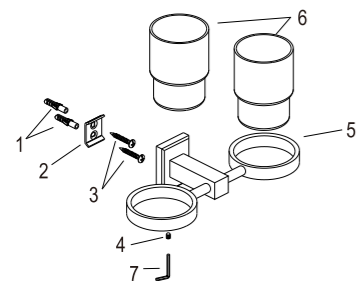

PARTS LIST		
No.	Part Name	Q'ty
1	Anchor	2
2	Holder seat	1
3	Self-tapping Screw	2
4	Set screw	1
5	Body	1
6	Cup	1
7	Allen Key	1

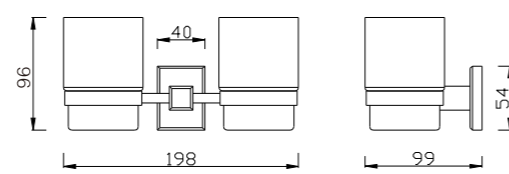

FFAS0483-908XXXBF0

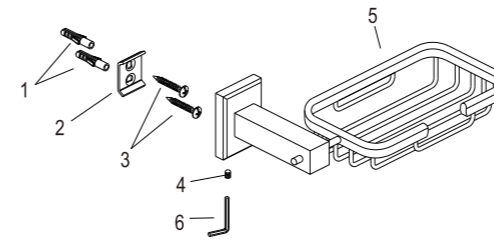

PARTS LIST		
No.	Part Name	Q'ty
1	Anchor	2
2	Holder seat	1
3	Self-tapping Screw	2
4	Set screw	1
5	Body	1
6	Allen Key	1

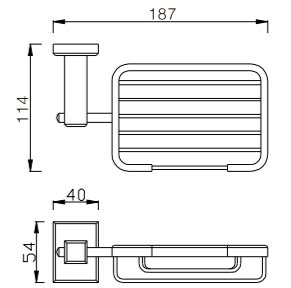

FFAS0486-908XXXBF0

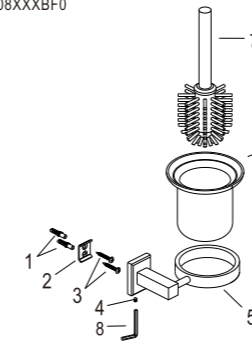

PARTS LIST		
No.	Part Name	Q'ty
1	Anchor	2
2	Holder seat	1
3	Self-tapping Screw	2
4	Set screw	1
5	Body	1
6	Cup	1
7	Brush	1
8	Allen Key	1

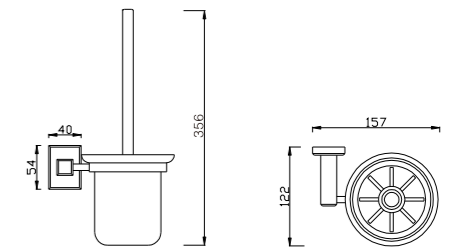

FFAS0491-908XXXBF0

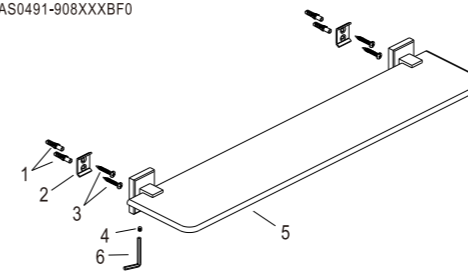

PARTS LIST		
No.	Part Name	Q'ty
1	Anchor	4
2	Holder seat	2
3	Self-tapping Screw	4
4	Set screw	2
5	Body	1
6	Allen Key	1

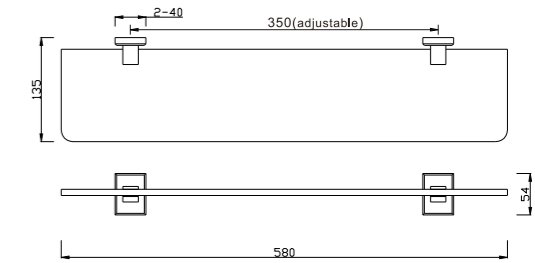

FFAS0492-908XXXBF0

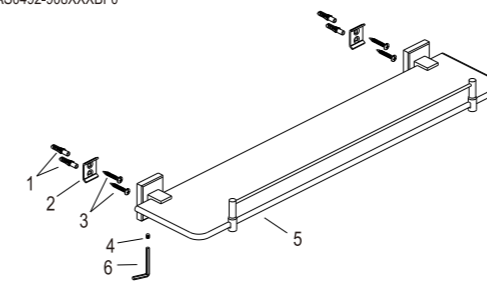

PARTS LIST		
No.	Part Name	Q'ty
1	Anchor	4
2	Holder seat	2
3	Self-tapping Screw	4
4	Set screw	2
5	Body	1
6	Allen Key	1

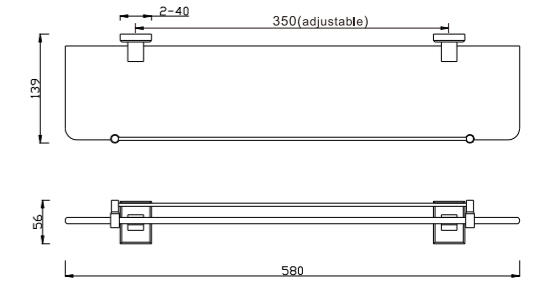

FFAS0495-908XXXBF0

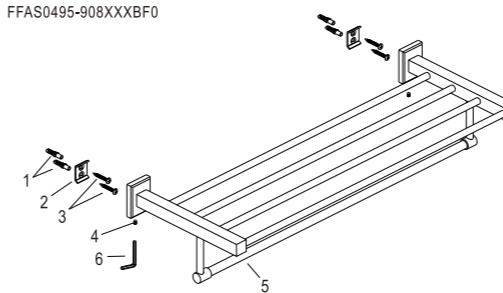

PARTS LIST		
No.	Part Name	Q'ty
1	Anchor	4
2	Holder seat	2
3	Self-tapping Screw	4
4	Set screw	2
5	Body	1
6	Allen Key	1

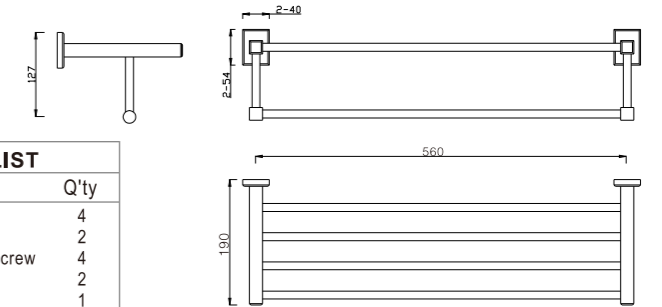

FFAS0487-908XXXBF0

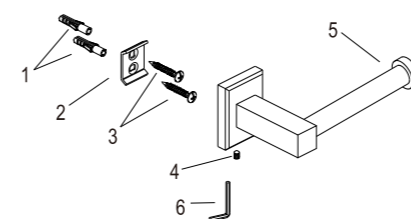

PARTS LIST		
No.	Part Name	Q'ty
1	Anchor	2
2	Holder seat	1
3	Self-tapping Screw	2
4	Set screw	1
5	Body	1
6	Allen Key	1

