

| Tolerance, Unless Otherwise Stated, Is | | |
|--|------|--|
| Above 0.5 to and including 6 | ±0.1 | |
| Excess 6 to and including 30 | ±0.2 | |
| Excess 30 to and including 120 | ±0.3 | |
| Excess 120 to and including 315 | ±0.5 | |
| Excess 315 to and including 1000 | ±0.8 | |
| Excess 1000 to and including 2000 | ±1.2 | |

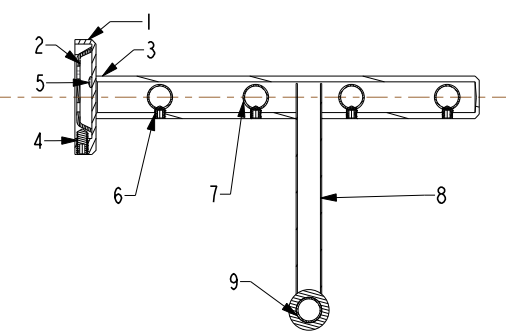

SECTION A-A

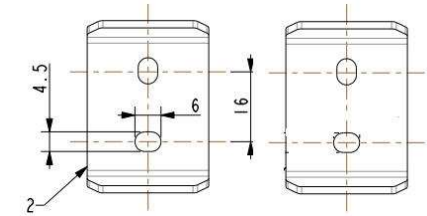
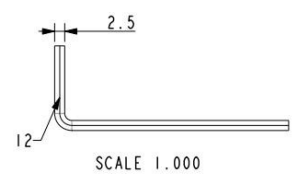
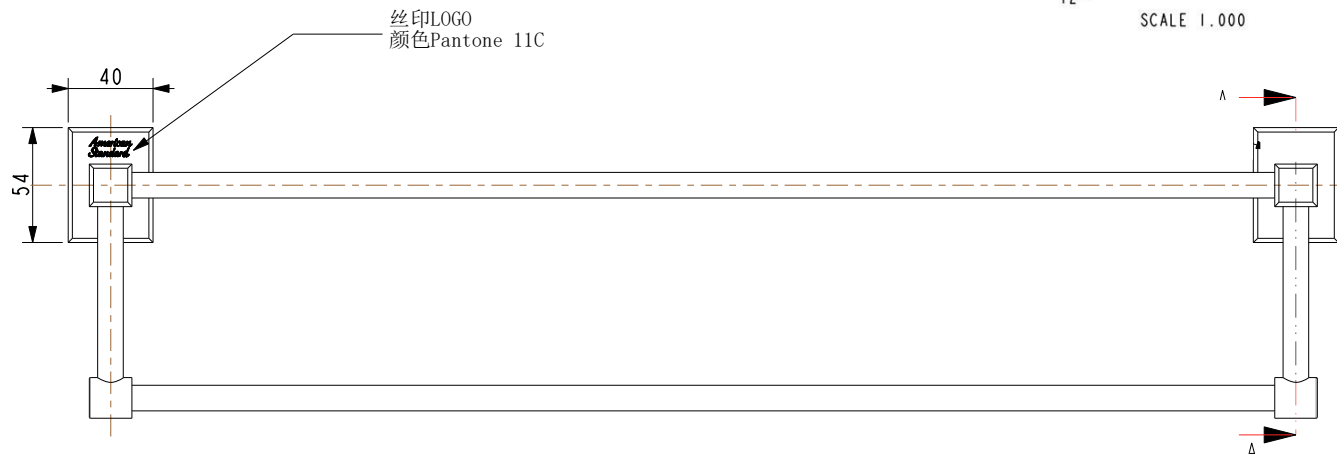
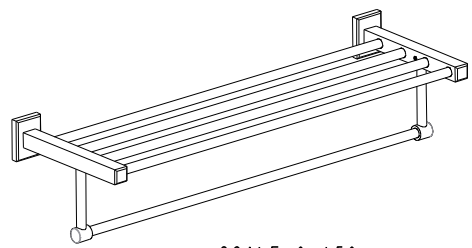
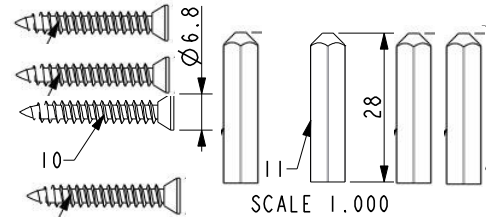
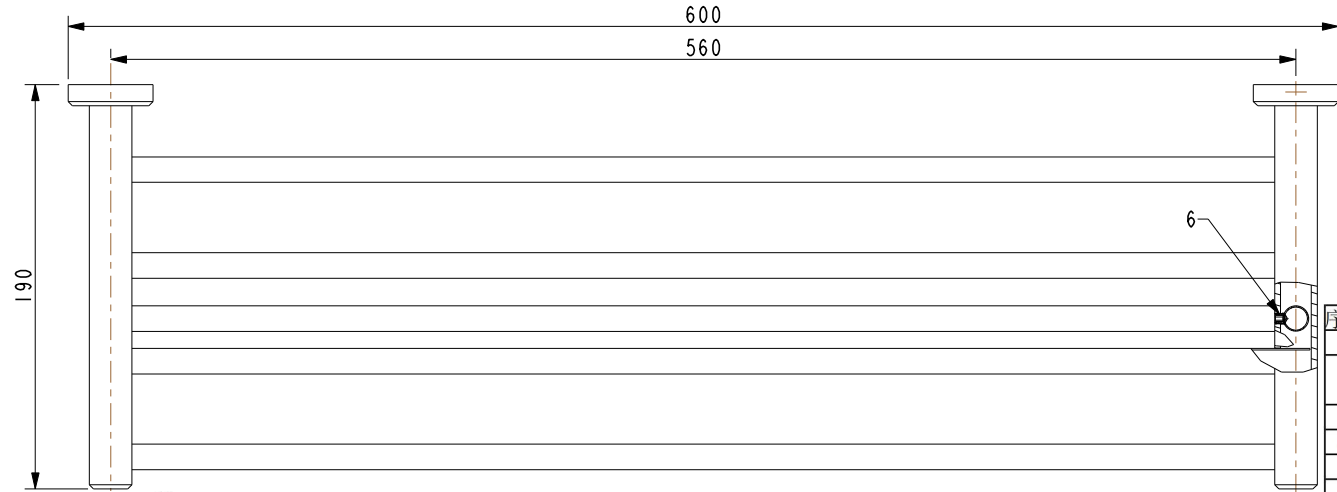

技术要求:

- 按《WI10.3204》浴室配件进货检验标准检验;
- 所有尺寸为一般尺寸。

| 序号 | 组件号 | 对象描述 | 材质 | 数量 | 备注 |
|----|--------------------|-------------|----------|----|----|
| 1 | FF1-CN521J00317A0X | 0481底座 星河灰 | ZZnA14-1 | 2 | |
| 3 | FF1-CN521B00053A0X | 0495左支杆 星河灰 | ZZnA14-1 | 1 | |
| | FF1-CN521B00054A0X | 0495右支杆 星河灰 | ZZnA14-1 | 1 | |
| 7 | FF1-CN521Z00237A0B | 0493直管 星河灰 | SUS201 | 5 | |
| 8 | FF1-CN521Z00240A0B | 0495挂杆座 星河灰 | H62 | 2 | |
| 2 | | | | | |
| 4 | | | | | |
| 5 | | | | | |
| 6 | FF1-CN521Z0024199S | 0495余下配件 | 组件 | 1 | |
| 10 | | | | | |
| 11 | | | | | |
| 12 | | | | | |

| | | | |
|----------|----------|------------|--------------------|
| DESIGNED | 利华决 | 2023.12.19 | TITLE |
| CHECKED | 张明 | 2023.12.19 | REF |
| APPROVED | 张明 | 2023.12.19 | 概念方毛巾架_星河灰 |
| SCALE | MATERIAL | WEIGHT | DWG NO. |
| 0.400 | Assembly | | FFAS0495-908A00BFO |



| REV | DESCRIPTION | DATE | NAME |
|-----|-------------|------|------|
| | | | |