

Trouble Shooting Guide

Trouble	Checkpoint	Contents	Action
Poor flow rate	Supply valve	Check valve position.	Open it to full valve.
Leakage	Cartridge seals	Check cartridge installation.	When seal is damaged, replace it with new one.
	Pipe connection	Check the connection.	Check the vinyl tape and Wind it up sufficiently.

Care & Maintenance

* If you want to do the maintenance for the faucet, please follow the below process.

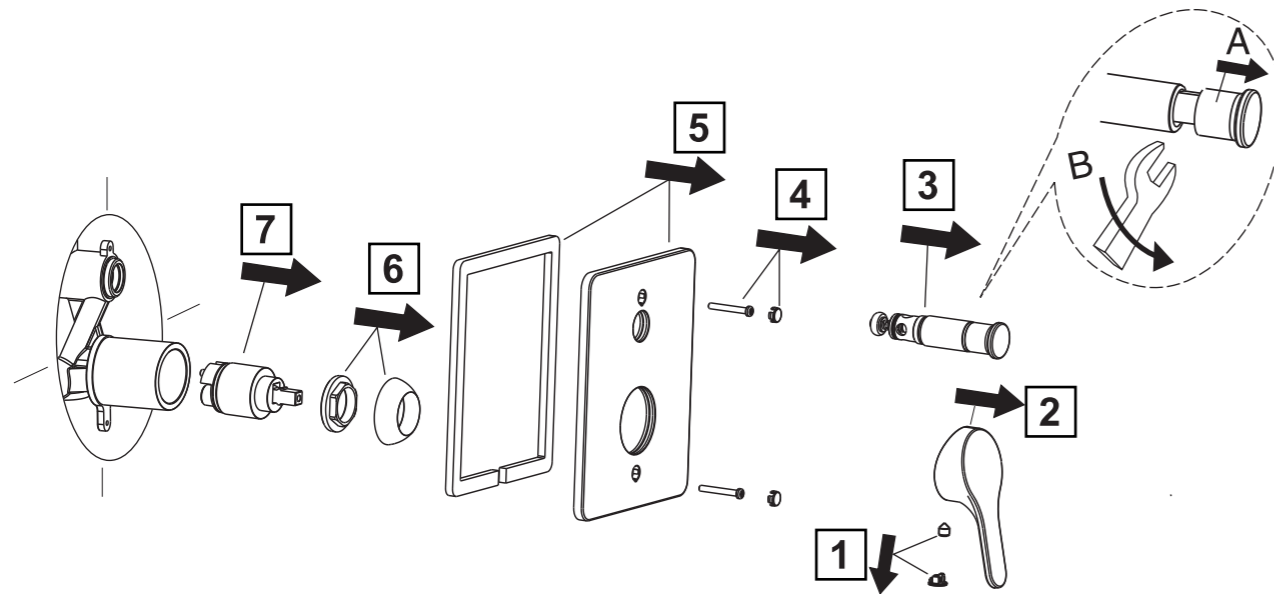

Attention:
Please Leave the manual to the customer after installation is finished.

Concept

FFAS1420-609500BF0 (WF-1420.609.50)
In-wall B&S Mixing Valve
FFAS1421-609500BF0 (WF-1421.609.50)
In-wall B&S Mixing Valve
FFAS1422-709500BF0 (WF-1422.709.50)
In-wall Shower Mixing Valve

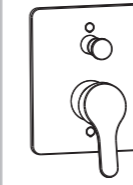

FFAS1420-609500BF0

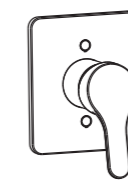

FFAS1421-609500BF0

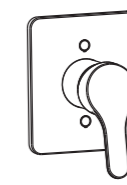

FFAS1422-709500BF0

American Standard

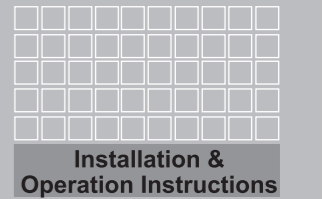

Installation & Operation Instructions

Thank you for selecting American-Standard - the benchmark of fine quality for over 100 years. To ensure that your installation proceeds smoothly--please read these instructions carefully before you begin.

* American Standard always keep raising and improving the product design and performance, and reserve the right to modify the dimension and specification. At this case, we will not inform you separately.

* This installation instruction sheet is for your reference only, the dimension and specification is subject to the actual products.

All instruction procedures must comply in strict accordance with applicable local plumbing and building codes

Pre-Installation Checks

*Remove all impurity in pipes before beginning to avoid clogging. Connect faucet pipes correctly. That is, the flexible hose with red mark is for HOT water, while the one with blue mark is for COLD water.

* Check installation distances in the Dimension diagram to ensure correct installation.

Conditions for use

* Recommended water pressure condition: 0.1~0.5Mpa.

* Environment Temperature:1~55°C

* Steam is not allowed to use.

* The cold and hot water pipes must not be reserved.

When in the process of installation, grab the whole body. Do not grab handle only.

Recommended Tools and Materials



Adjustable Wrench



Level

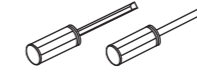

Screwdriver



Tape Measure



Windtight Swathe



Pencil

Dimension

Unit: mm

FFAS1420-609500BF0

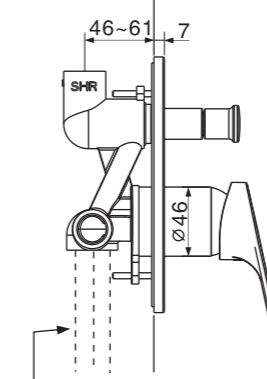
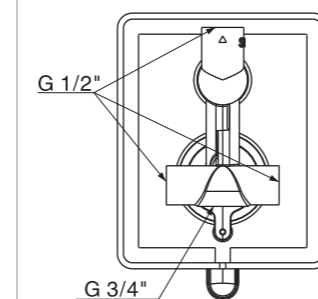
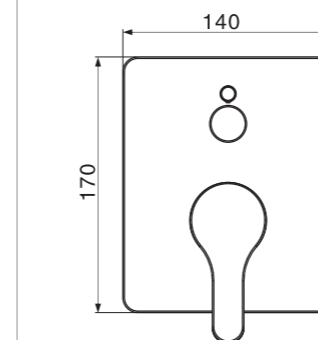

■ The inner diameter of pipe from body to spout(including connector) need to be more than 13mm

FFAS1421-609500BF0 / FFAS1422-709500BF0

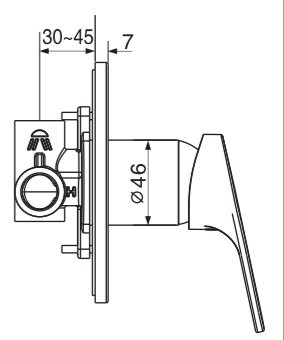
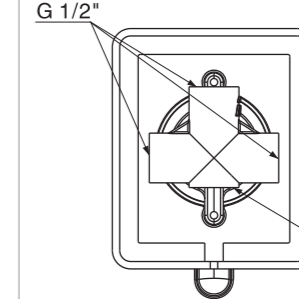
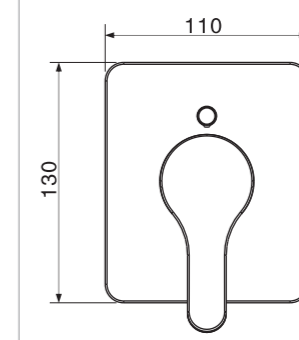

Parts List

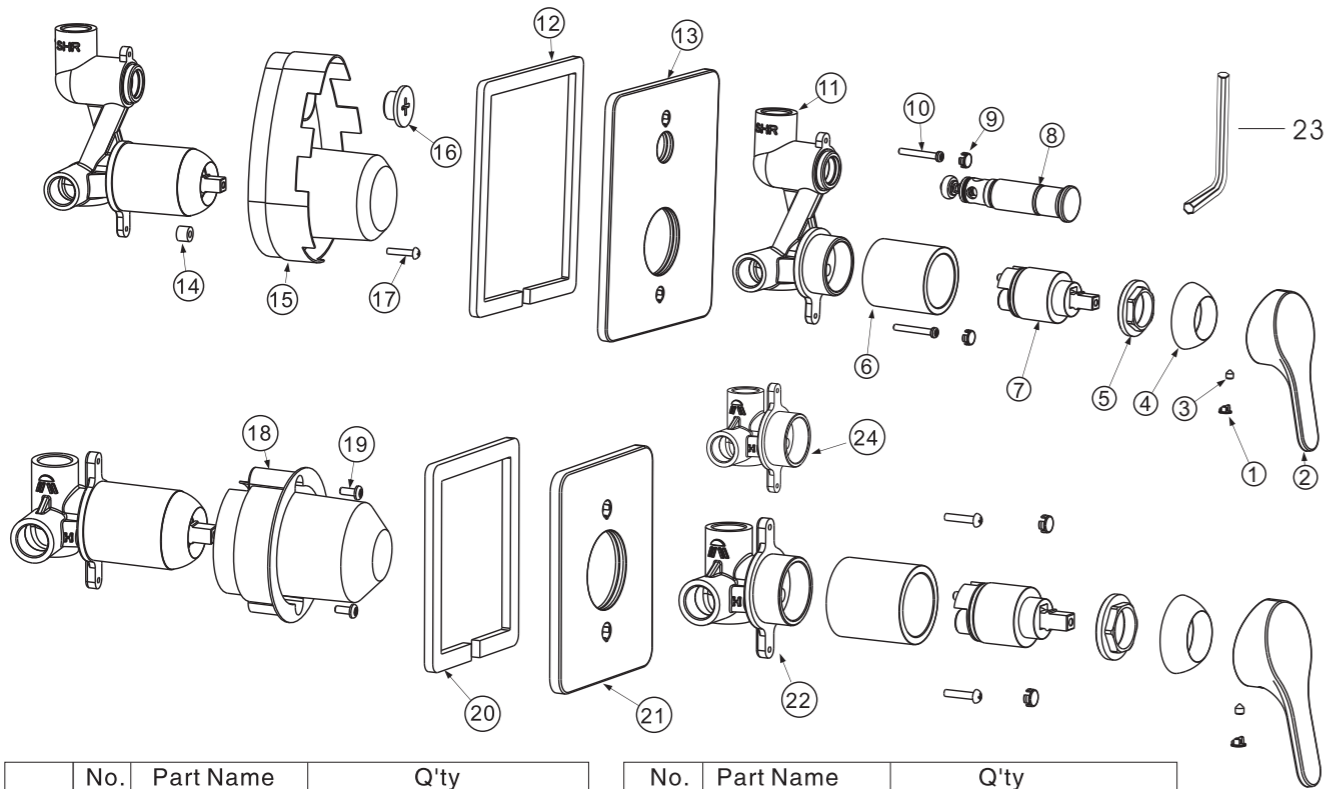

No.	Part Name	Q'ty		
		FFAS1420	FFAS1421	FFAS1422
1	Index Button	1	1	1
2	Handle	1	1	1
3	Screw	1	1	1
4	Cap	1	1	1
5	Nut	1	1	1
6	Tube	1	1	1
7	Cartridge	1	1	1
8	Divertor	1	0	0
9	Cap	2	2	2
10	Screw	2	2	2
11	Body	1	0	0
12	Washer	1	0	0

No.	Part Name	Q'ty		
		FFAS1420	FFAS1421	FFAS1422
13	Escutcheon	1	0	0
14	Washer	1	0	0
15	Cover	1	0	0
16	Screw	1	0	0
17	Screw	1	0	0
18	Cover	0	1	1
19	Screw	0	1	1
20	Washer	0	1	1
21	Escutcheon	0	1	1
22	Body	0	1	0
23	In-hex Wrench	1	1	1
24	Body	0	0	1

Installations

1 Installing Body

- * Install BODY with PLASTER GUARD at the indicated height and depth. Make sure the installation direction is in accordance with the drawing.
- * Connect RISER PIPE to the top outlet of BODY. Install ELBOW and UPPER NIPPLE.
- * Connect TUB FILLER PIPE to the bottom outlet of BODY. Install ELBOW and LOWER NIPPLE.
- * Secure pipes on FIXED BOARD with BRACE. Cap UPPER NIPPLE and LOWER NIPPLE with PLUGS. Remove PLASTER GUARD, then install DIVERTER.
- * Turn on water supplies to check for leaks. Move handle to "on" position to check for leak.
- * Move handle into "off" position and shut off water supplies.
- * Remove DIVERTER and replace PLASTER GUARD.
- * Finish wall construction.

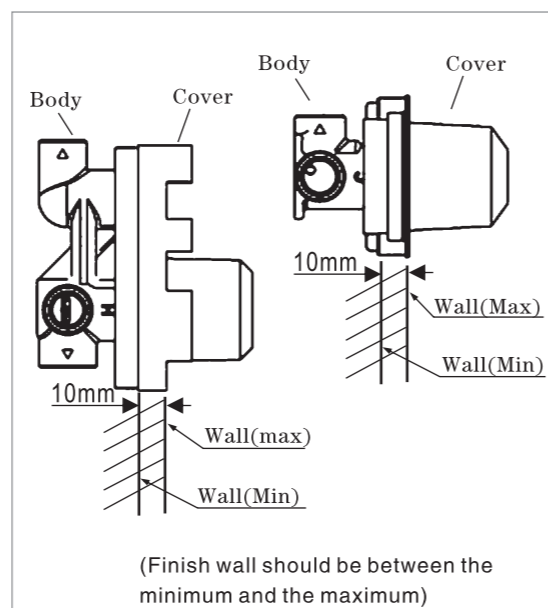
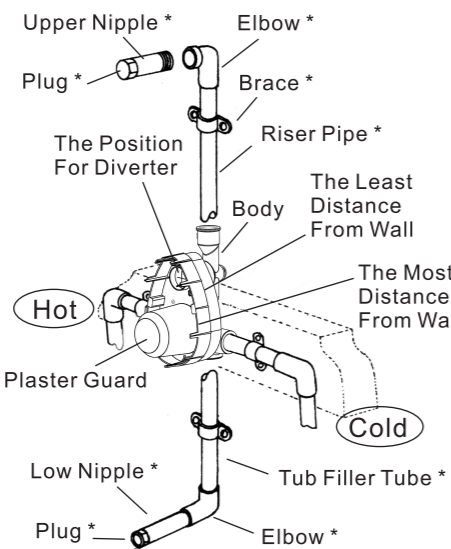

2 Installing Handle

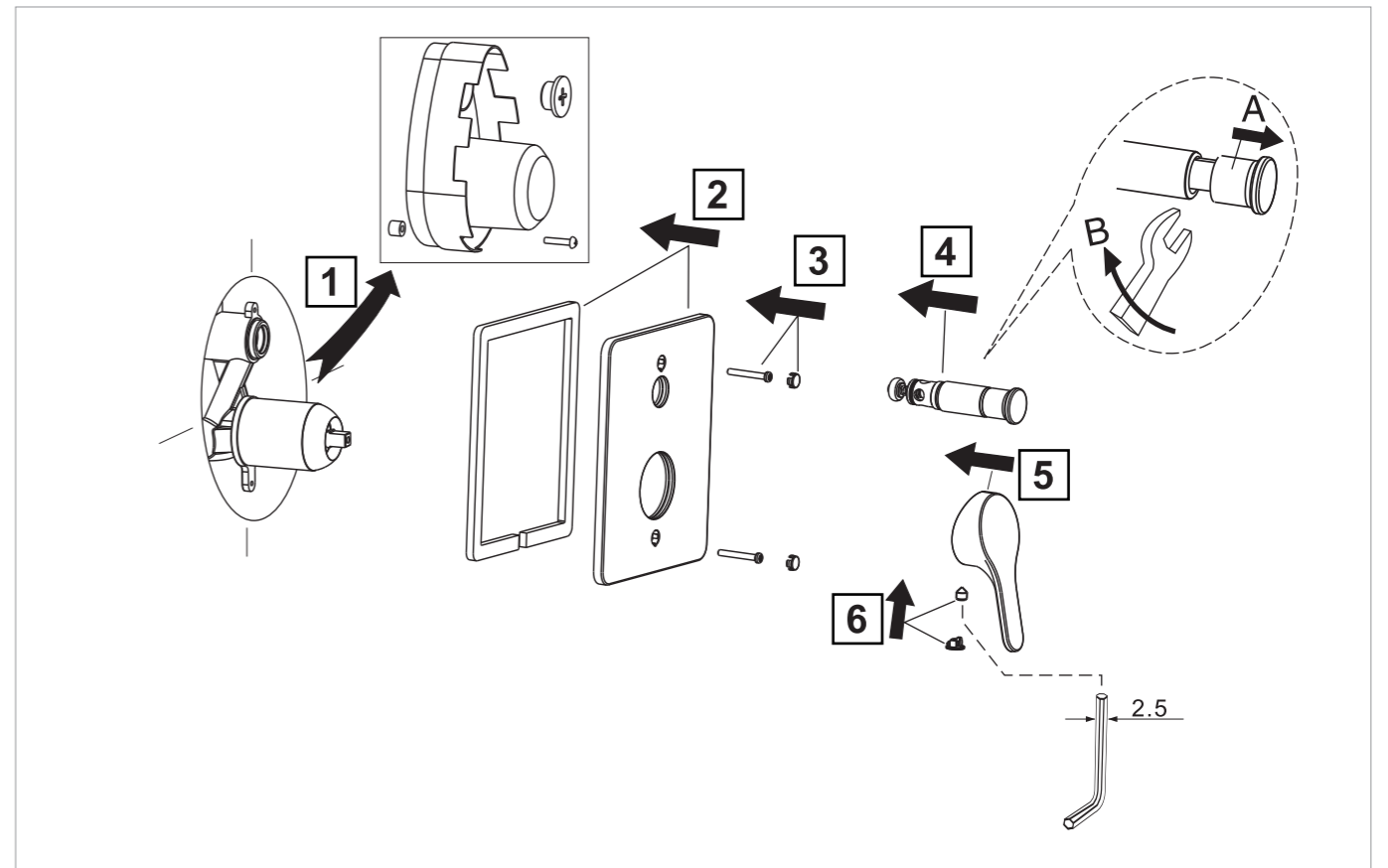

Test & Usage

1 Test

- * Move handle down into "off" position. Turn on supply angle valve to check all connections for leak.
- * Operate handle up and down, left and right to flush water lines thoroughly.

2 Usage

