

To ensure that your installation proceeds smoothly, please read this instructions carefully before you begin.

American Standard

FFAS9141-000500BT0

Wall Outlet with holder- Round (R1/2")

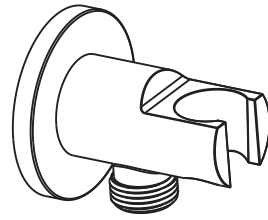

Installation & Operation Instruction

Dimension

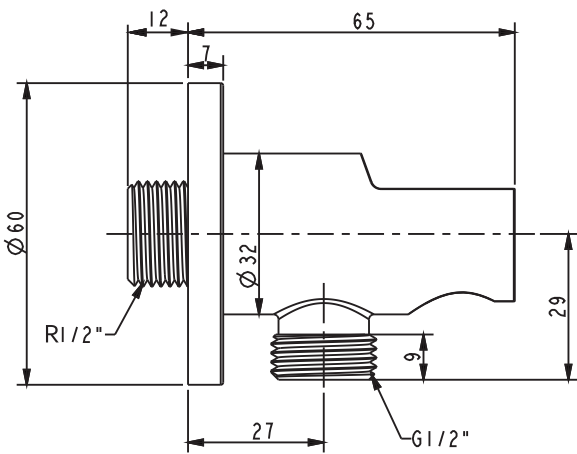

Install

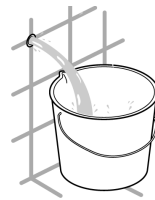

- 1** * Consult the dimension drawing and lay the pipes.
* Wash and clean the water supply pipeline.

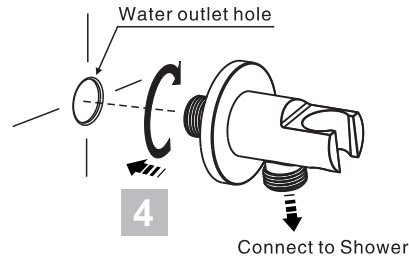
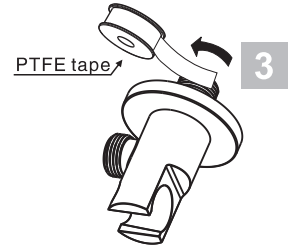
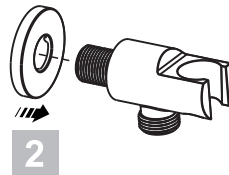

Parts List

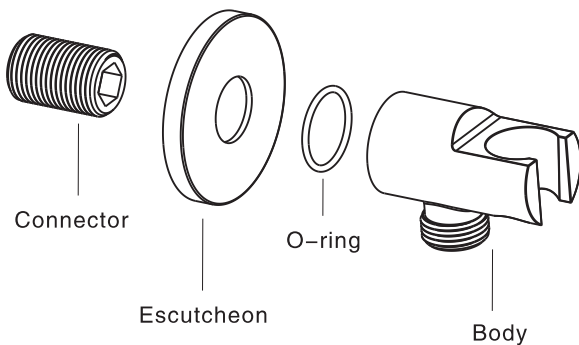

Notice

Remove all impurity in pipes before beginning to avoid clogging. Connect faucet pipes correctly.

When you repair the faucet you will need to shut off hot/cold water supply by closing the water supply.

Conditions for use

- * Water pressure condition: 0.1MPa~0.75MPa (Recommended : 0.1MPa~0.5Mpa)
- * Environment Temperature: 1°C~55°C
- * Not for use as a steam outlet.

Cleaning the surface of faucet

- * Rinse the product with clean water.
- * Dry with soft cotton flannel cloth.
- * Do not clean the product with acid, polish, abrasives, harsh cleaners, or cloth with a harsh surface as these products may damage the finish.